

1.4MHz, 1.5A ASYNCHRONOUS DC-DC BUCK CONVERTER AP3211H**General Description**

The AP3211H is a 1.4MHz fixed frequency, current mode, PWM buck (step-down) DC-DC converter, capable of driving a 1.5A load with high efficiency, excellent line and load regulation. The device integrates N-channel power MOSFET switch with low on-resistance. Current mode control provides fast transient response and cycle-by-cycle current limit.

A standard series of inductors are available from several different manufacturers optimized for use with the AP3211H. This feature greatly simplifies the design of switch-mode power supplies.

The AP3211H is available in SOT-23-6 package.

Features

- Input Voltage Range: 4.5V to 23V
- Fixed 1.4MHz Frequency
- High Efficiency: up to 92%
- Output Current: 1.5A
- Current Mode Control
- Built-in Over Current Protection
- Built-in Thermal Shutdown Function
- Built-in UVLO Function
- Built-in Over Voltage Protection
- Built-in Soft-start

Applications

- LCD TV
- DPF
- Portable DVD

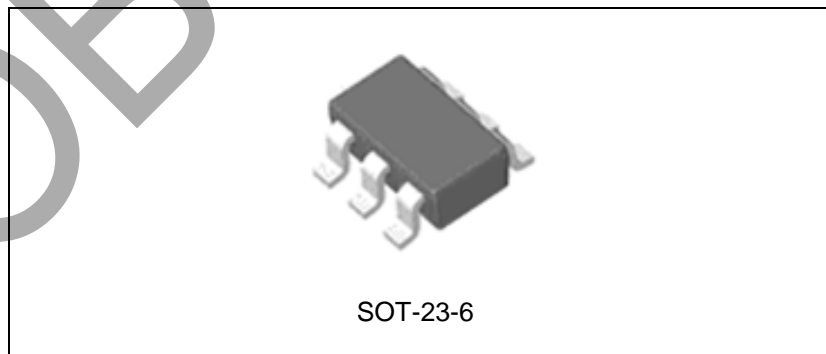

Figure 1. Package Type of AP3211H

1.4MHz, 1.5A ASYNCHRONOUS DC-DC BUCK CONVERTER AP3211H

Pin Configuration

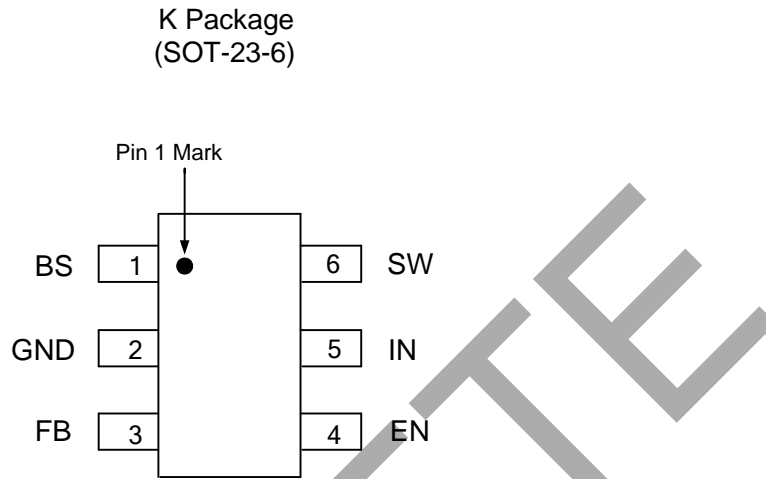

Figure 2. Pin Configuration of AP3211H (Top View)

Pin Description

| Pin Number | Pin Name | Function |
|------------|----------|---|
| 1 | BS | Bootstrap pin. A bootstrap capacitor is connected between the BS pin and SW pin. The voltage across the bootstrap capacitor drives the internal high-side NMOS switch |
| 2 | GND | Ground pin |
| 3 | FB | Feedback pin. This pin is connected to an external resistor divider to program the system output voltage. When V_{FB} exceeds 20% of the nominal regulation value of 0.81V, the OVP is triggered. When $V_{FB} < 0.25V$, the oscillator frequency is lowered to realize short circuit protection |
| 4 | EN | Control input pin. Forcing this pin above 1.5V enables the IC. Forcing this pin below 0.4V shuts down the IC. When the IC is in shutdown mode, all functions are disabled to decrease the supply current below 1 μ A |
| 5 | IN | Supply input pin. A capacitor should be connected between the IN pin and GND pin to keep the DC input voltage constant |
| 6 | SW | Power switch output pin. This pin is connected to the inductor and bootstrap capacitor |



PART OBSOLETE - USE AP3211 and AP5100

Preliminary Datasheet

1.4MHz, 1.5A ASYNCHRONOUS DC-DC BUCK CONVERTER AP3211H

Functional Block Diagram

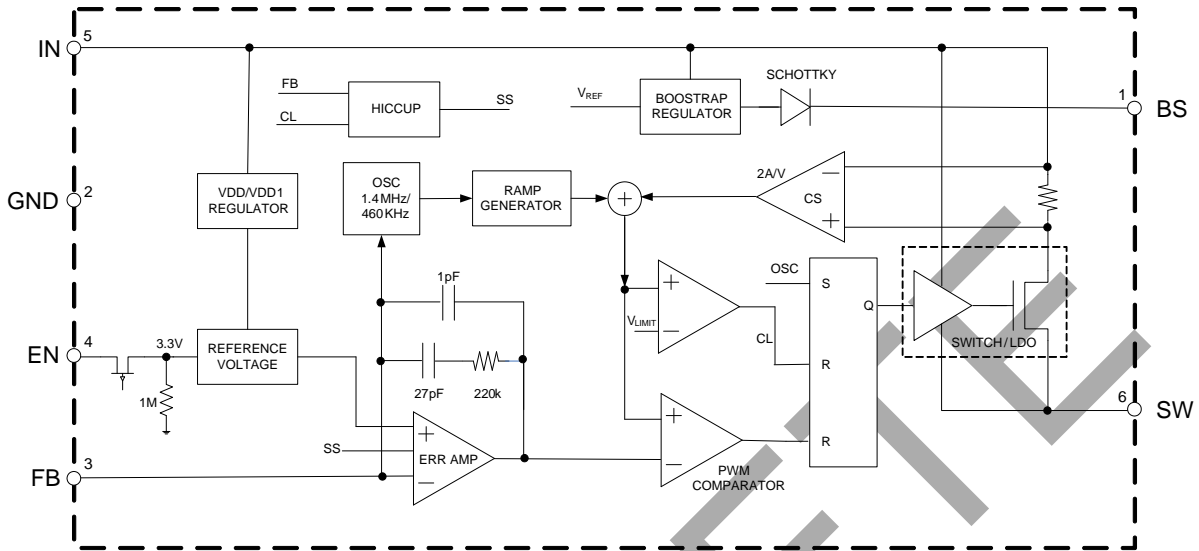
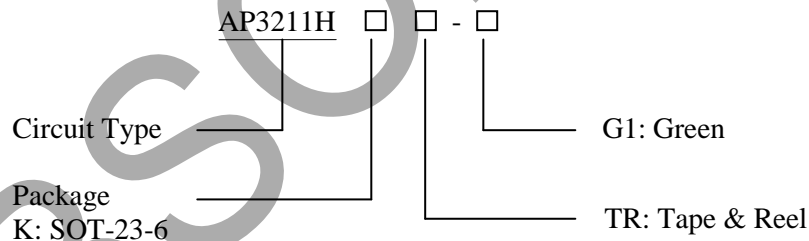

Figure 3. Functional Block Diagram of AP3211H

Ordering Information



| Package | Temperature Range | Part Number | Marking ID | Packing Type |
|----------|-------------------|---------------|------------|--------------|
| SOT-23-6 | -40 to 85°C | AP3211HKTR-G1 | GBK | Tape & Reel |

BCD Semiconductor's Pb-free products, as designated with "G1" suffix in the part number, are RoHS compliant and green.

OBSOLETE - PART DISCONTINUED



1.4MHz, 1.5A ASYNCHRONOUS DC-DC BUCK CONVERTER AP3211H

Absolute Maximum Ratings (Note 1)

| Parameter | Symbol | Value | Unit |
|---|---------------|----------------------|------|
| Input Pin Voltage | V_{IN} | -0.3 to 25 | V |
| EN Pin Voltage | V_{EN} | -0.3 to $V_{IN}+0.3$ | V |
| SW Pin Voltage | V_{SW} | 26 | V |
| Bootstrap Pin Voltage | V_{BS} | -0.3 to $V_{SW}+6$ | V |
| Feedback Pin Voltage | V_{FB} | -0.3 to 6 | V |
| Operating Junction Temperature | T_J | 150 | °C |
| Storage Temperature | T_{STG} | -65 to 150 | °C |
| Lead Temperature (Soldering, 10sec) | T_{LEAD} | 260 | °C |
| Thermal Resistance (Junction to Ambient) | θ_{JA} | 220 | °C/W |

Note 1: Stresses greater than those listed under “Absolute Maximum Ratings” may cause permanent damage to the device. These are stress ratings only, and functional operation of the device at these or any other conditions beyond those indicated under “Recommended Operating Conditions” is not implied. Exposure to “Absolute Maximum Ratings” for extended periods may affect device reliability.

Recommended Operating Conditions

| Parameter | Symbol | Min | Max | Unit |
|-------------------------------|----------|-----|-----|------|
| Input Voltage | V_{IN} | 4.5 | 23 | V |
| Operating Ambient Temperature | T_A | -40 | 85 | °C |

**1.4MHz, 1.5A ASYNCHRONOUS DC-DC BUCK CONVERTER AP3211H****Electrical Characteristics**

$V_{IN}=V_{EN}=12V$, $V_{OUT}=3.3V$, $T_A=25\text{ }^\circ\text{C}$, unless otherwise specified.

| Parameter | Symbol | Conditions | Min | Typ | Max | Unit |
|---------------------------------|------------|-------------------------------|-------|-------|-------|------------------|
| Input Voltage | V_{IN} | | 4.5 | | 23 | V |
| Quiescent Current | I_Q | $V_{FB}=0.9V$ | | 0.8 | 1.1 | mA |
| Shutdown Supply Current | I_{SHDN} | $V_{EN}=0V$ | | 0.1 | 1.0 | μA |
| Feedback Voltage | V_{FB} | | 0.785 | 0.810 | 0.835 | V |
| Feedback Over Voltage Threshold | V_{FBOV} | | | 0.972 | | V |
| Feedback Bias Current | I_{FB} | $V_{FB}=0.85V$ | -0.1 | | 0.1 | μA |
| Switch On-resistance | R_{DSON} | $I_{SW}=1A$ | | 0.385 | | Ω |
| Switch Leakage Current | I_{LEAK} | $V_{IN}=23V$, $V_{EN}=0V$ | | 0.1 | 10 | μA |
| Switch Current Limit | I_{LIM} | | 1.8 | 2.4 | | A |
| EN Pin Threshold | V_{ENH} | | 1.5 | | | V |
| | V_{ENL} | | | | 0.4 | |
| Input UVLO Threshold | V_{UVLO} | V_{IN} Rising | 3.3 | 3.8 | 4.3 | V |
| Input UVLO Hysteresis | V_{HYS} | | | 0.2 | | V |
| Oscillator Frequency | f_{OSC1} | | 1.1 | 1.4 | 1.7 | MHz |
| | f_{OSC2} | Short Circuit | | 460 | | kHz |
| Max. Duty Cycle | D_{MAX} | $V_{FB}=0.6V$ | | 90 | | % |
| Min. Duty Cycle | D_{MIN} | $V_{FB}=0.9V$ | | | 0 | % |
| Minimum On Time | t_{ON} | | | 100 | | ns |
| Thermal Shutdown | T_{OTSD} | | | 160 | | $^\circ\text{C}$ |
| Thermal Shutdown Hysteresis | T_{HYS} | | | 20 | | $^\circ\text{C}$ |
| Soft-start Time | t_{SS} | | | 200 | | μs |

Note 2: R_{DSON} , t_{ON} , T_{OTSD} , T_{HYS} and t_{SS} are guaranteed by design.



1.4MHz, 1.5A ASYNCHRONOUS DC-DC BUCK CONVERTER AP3211H

Typical Performance Characteristics

$T_A=25\text{ }^\circ\text{C}$, $V_{IN}=12\text{V}$, $V_{OUT}=3.3\text{V}$, unless otherwise noted.

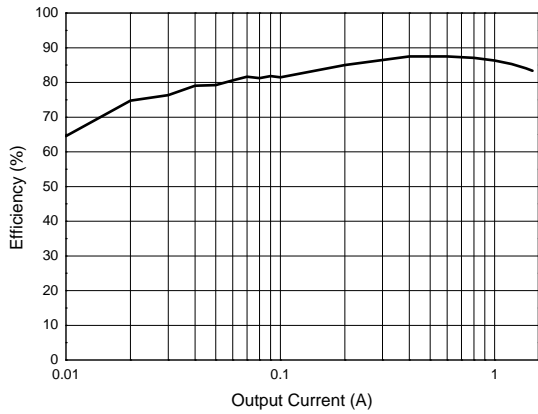

Figure 4. Efficiency vs. Output Current

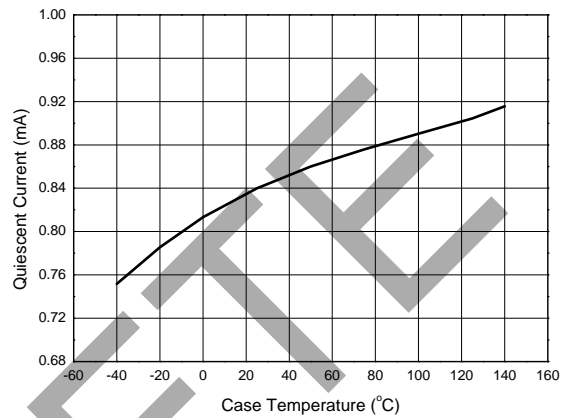

Figure 5. Quiescent Current vs. Case Temperature

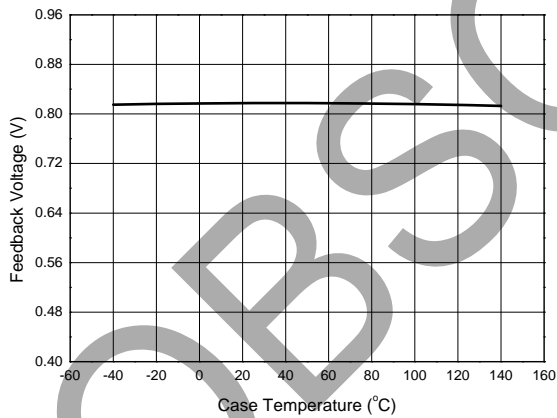

Figure 6. Feedback Voltage vs. Case Temperature

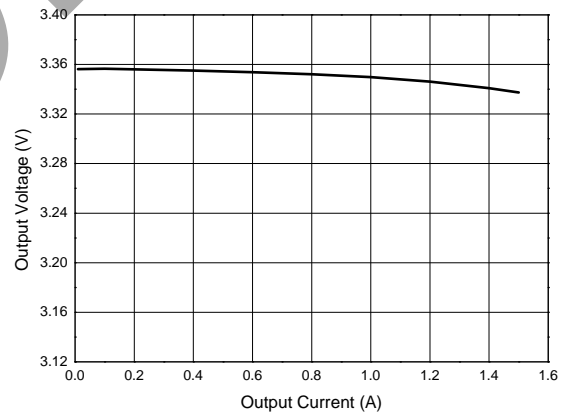

Figure 7. Output Voltage vs. Output Current



1.4MHz, 1.5A ASYNCHRONOUS DC-DC BUCK CONVERTER AP3211H

Typical Performance Characteristics (Continued)

T_A=25 °C, V_{IN}=12V, V_{OUT}=3.3V, unless otherwise noted.

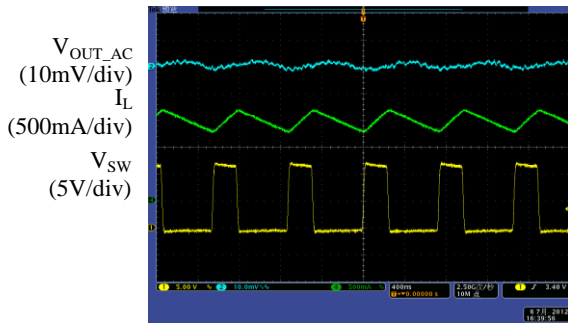

Time (400ns/div)

Figure 8. Output Ripple (I_{OUT}=1.5A)

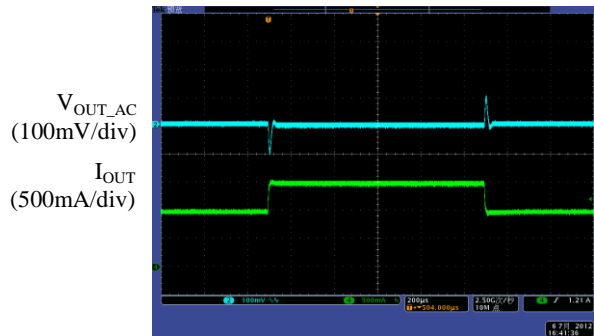

Time (200µs/div)

Figure 9. Load Transient (I_{OUT}=1A to 1.5A)

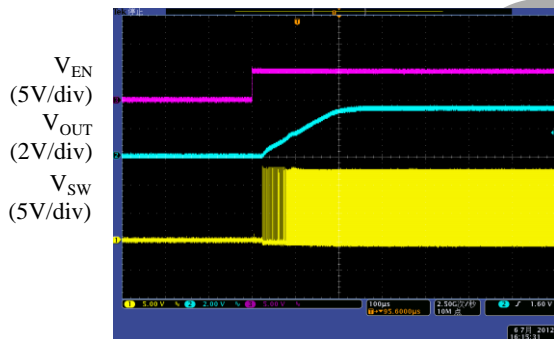

Time (100µs/div)

Figure 10. Enable Turn on Characteristic

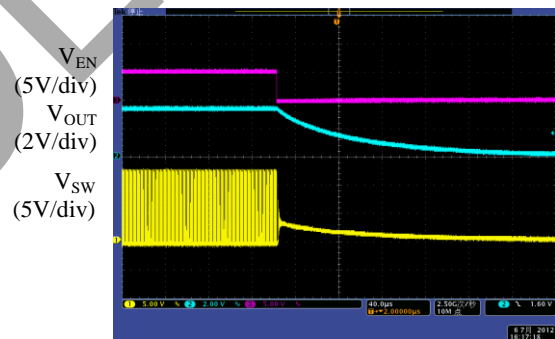

Time (40µs/div)

Figure 11. Enable Turn off Characteristic

OBSOLETE - PART DISCONTINUED



1.4MHz, 1.5A ASYNCHRONOUS DC-DC BUCK CONVERTER AP3211H

Typical Performance Characteristics (Continued)

$T_A=25\text{ }^\circ\text{C}$, $V_{IN}=12\text{V}$, $V_{OUT}=3.3\text{V}$, unless otherwise noted.

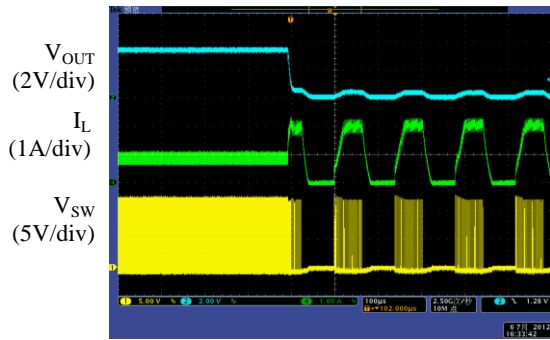

Time (100µs/div)

Figure 12. Short Circuit Protection ($I_{OUT}=1\text{A}$)

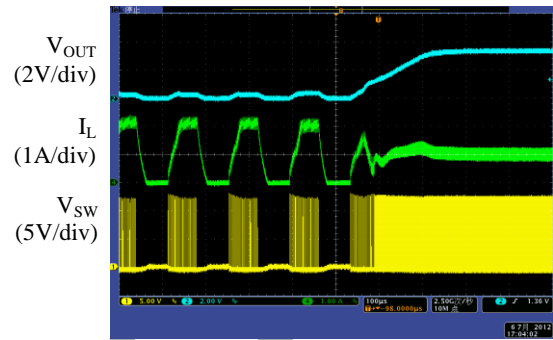

Time (100µs/div)

Figure 13. Short Circuit Recovery ($I_{OUT}=1\text{A}$)

OBSOLETE

OBSOLETE - PART DISCONTINUED

1.4MHz, 1.5A ASYNCHRONOUS DC-DC BUCK CONVERTER AP3211H

Typical Application

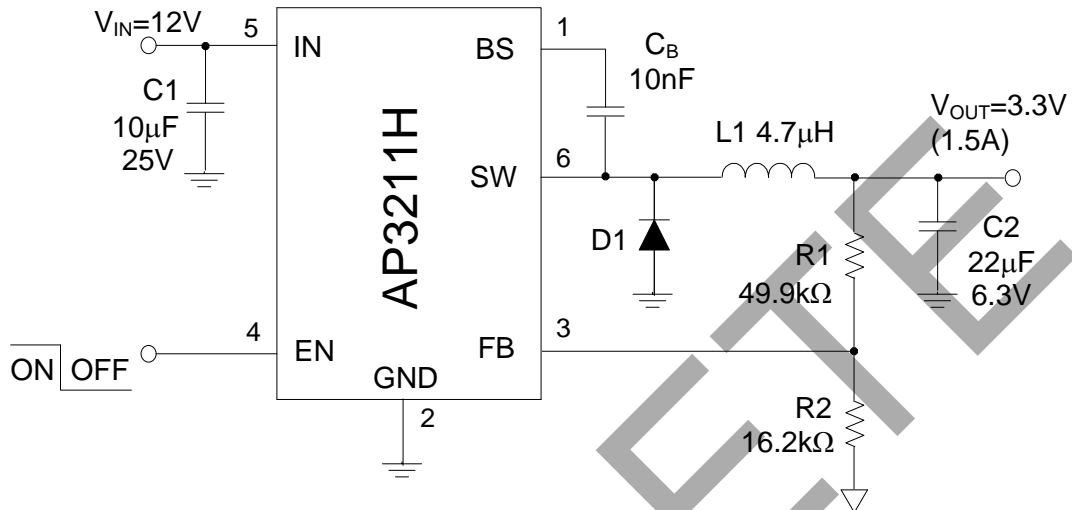

Figure 14. Typical Application Circuit of AP3211H

OBSOLETE - PART DISCONTINUED



PART OBSOLETE - USE AP3211 and AP5100

Preliminary Datasheet

1.4MHz, 1.5A ASYNCHRONOUS DC-DC BUCK CONVERTER AP3211H

Mechanical Dimensions

SOT-23-6

Unit: mm(inch)

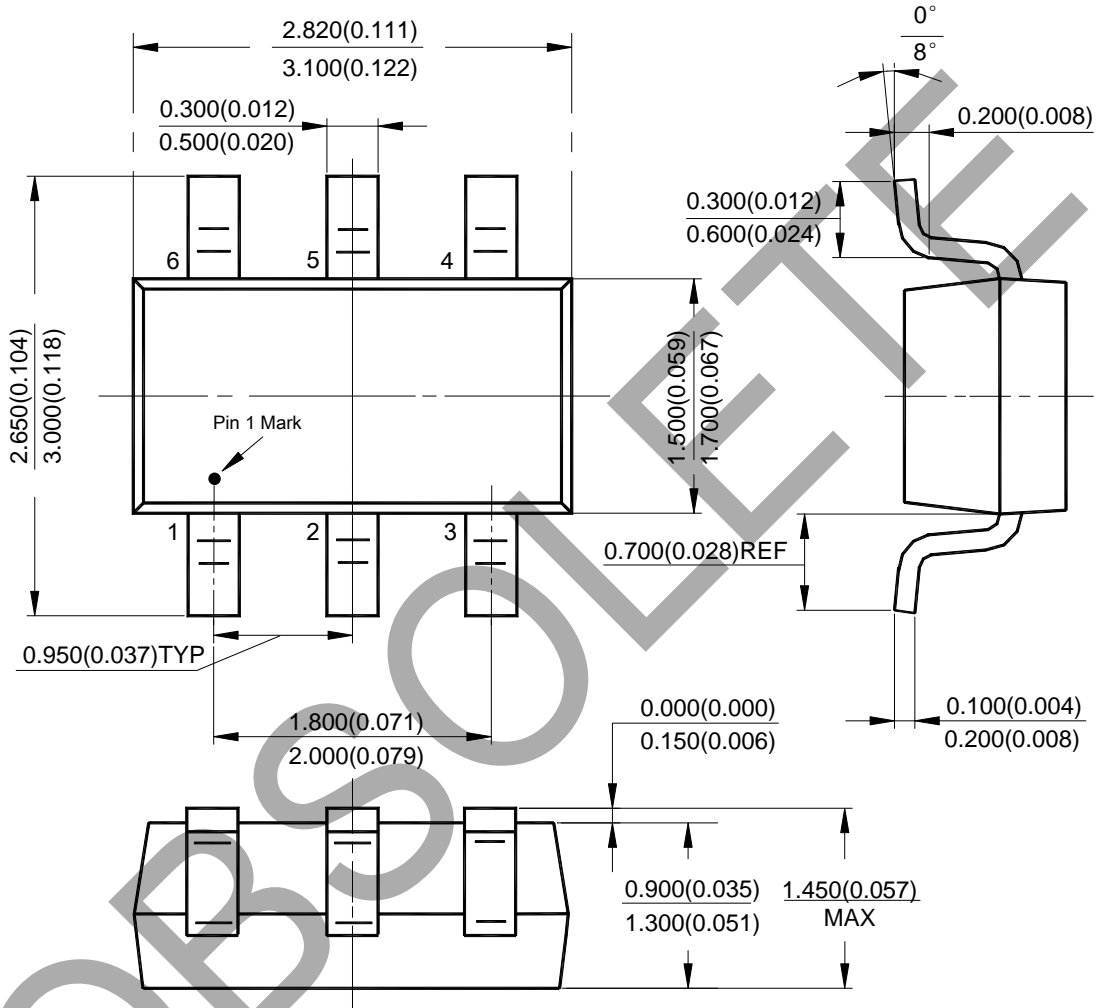

OBSELETE - PART DISCONTINUED

1.4MHz, 1.5A ASYNCHRONOUS DC-DC BUCK CONVERTER AP3211H

Mounting Pad Layout

SOT-23-6

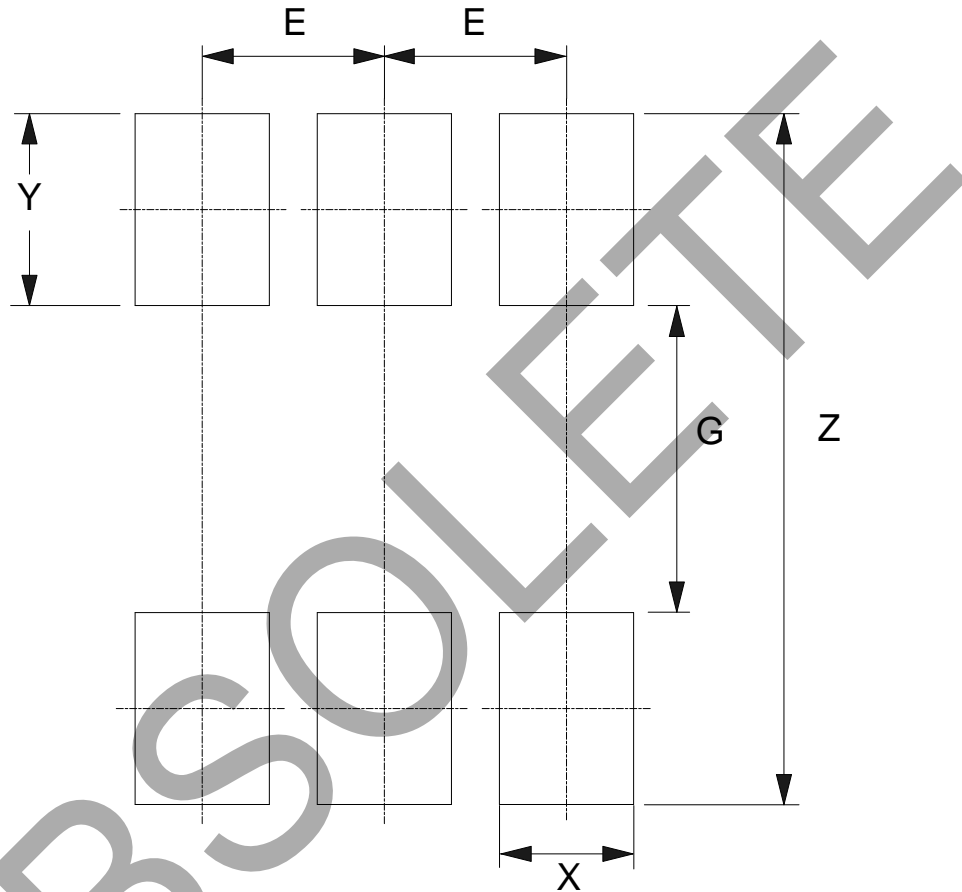

| Dimensions | Z | G | X | Y | E |
|------------|-------------|-------------|-------------|-------------|-------------|
| | (mm)/(inch) | (mm)/(inch) | (mm)/(inch) | (mm)/(inch) | (mm)/(inch) |
| Value | 3.600/0.142 | 1.600/0.063 | 0.700/0.028 | 1.000/0.039 | 0.950/0.037 |

OBSOLETE - PART DISCONTINUED



BCD Semiconductor Manufacturing Limited

<http://www.bcdsemi.com>

IMPORTANT NOTICE

BCD Semiconductor Manufacturing Limited reserves the right to make changes without further notice to any products or specifications herein. BCD Semiconductor Manufacturing Limited does not assume any responsibility for use of any its products for any particular purpose, nor does BCD Semiconductor Manufacturing Limited assume any liability arising out of the application or use of any its products or circuits. BCD Semiconductor Manufacturing Limited does not convey any license under its patent rights or other rights nor the rights of others.

MAIN SITE

- Headquarters

BCD (Shanghai) Micro-electronics Limited

No. 1600, Zi Xing Road, Shanghai ZiZhu Science-based Industrial Park, 200241, P. R. C.
Tel: +86-021-2416-2266, Fax: +86-021-2416-2277

- Wafer Fab

Shanghai SIM-BCD Semiconductor Manufacturing Co., Ltd.

800 Yishan Road, Shanghai 200233, China
Tel: +021-6485-1491, Fax: +86-021-5450-0008

REGIONAL SALES OFFICE

Shenzhen Office

Shanghai SIM-BCD Semiconductor Manufacturing Co., Ltd., Shenzhen Office

Unit A Room 1203, Skyworth Bldg., Gaoxin Ave.1.S., Nanshan District
Shenzhen 518057, China

Tel: +86-0755-8660-4900, Fax: +86-0755-8660-4958

Taiwan Office (Taipei)

BCD Semiconductor (Taiwan) Company Limited

3F, No.17, Lane 171, Sec. 2, Jiu-Zong Rd., Nei-Hu Dist., Taipei(114), Taiwan, R.O.C
Tel: +886-2-2656 2808

Fax: +886-2-2656-2806/26562950

Taiwan Office (Hsinchu)

BCD Semiconductor (Taiwan) Company Limited

8F, No.176, Sec. 2, Gong-Dao 5th Road, East District
HsinChu City 300, Taiwan, R.O.C

Tel: +886-3-5160181, Fax: +886-3-5160181

USA Office

BCD Semiconductor Corp.

48460 Kato Road, Fremont, CA 94538, USA
Tel: +1-510-668-1950

Fax: +1-510-668-1990

Korea Office

BCD Semiconductor Limited Korea office.

Room 101-1112, Digital-Empire II, 486 Sin-dong,
Yeongtong-Gu, Suwon-city, Gyeonggi-do, Korea

Tel: +82-31-695-8430